

# Pressure Measurement

Transmitters for applications with advanced requirements (Advanced)

## SITRANS P DS III for gauge/absolute pressure, with front-flush diaphragm

### Technical specifications

#### SITRANS P DS III series for gauge and absolute pressure, with front-flush diaphragm

Input of gauge pressure, with front-flush diaphragm																									
Measured variable	Gauge pressure, front-flush																								
Span (continuously adjustable) or measuring range, max. operating pressure and max. test pressure	<table border="1"> <thead> <tr> <th>HART</th> <th>PROFIBUS PA/ FOUNDATION Fieldbus</th> <th>Max. operating pressure MAWP (PS)</th> <th>Max. perm. test pressure</th> </tr> </thead> <tbody> <tr> <td>Span</td> <td>Nominal measuring range</td> <td></td> <td></td> </tr> <tr> <td>0.01 ... 1 bar 1 ... 100 kPa 0.15 ... 14.5 psi</td> <td>1 bar 100 kPa 14.5 psi</td> <td>4 bar 400 kPa 58 psi</td> <td>6 bar 600 kPa 87 psi)</td> </tr> <tr> <td>0.04 ... 4 bar 4 ... 400 kPa 0.58 ... 58 psi</td> <td>4 bar 400 kPa 58 psi</td> <td>7 bar 0.7 MPa 102 psi</td> <td>10 bar 1 MPa 145 psi</td> </tr> <tr> <td>0.16 ... 16 bar 16 ... 1600 kPa 2.3 ... 232 psi</td> <td>16 bar 1600 kPa 232 psi</td> <td>21 bar 2.1 MPa 305 psi</td> <td>32 bar 3.2 MPa 464 psi</td> </tr> <tr> <td>0.63 ... 63 bar 63 ... 6300 kPa 9.1 ... 914 psi</td> <td>63 bar 6300 kPa 914 psi</td> <td>67 bar 6.7MPa 972 psi</td> <td>100 bar 10 MPa 1450 psi</td> </tr> </tbody> </table>	HART	PROFIBUS PA/ FOUNDATION Fieldbus	Max. operating pressure MAWP (PS)	Max. perm. test pressure	Span	Nominal measuring range			0.01 ... 1 bar 1 ... 100 kPa 0.15 ... 14.5 psi	1 bar 100 kPa 14.5 psi	4 bar 400 kPa 58 psi	6 bar 600 kPa 87 psi)	0.04 ... 4 bar 4 ... 400 kPa 0.58 ... 58 psi	4 bar 400 kPa 58 psi	7 bar 0.7 MPa 102 psi	10 bar 1 MPa 145 psi	0.16 ... 16 bar 16 ... 1600 kPa 2.3 ... 232 psi	16 bar 1600 kPa 232 psi	21 bar 2.1 MPa 305 psi	32 bar 3.2 MPa 464 psi	0.63 ... 63 bar 63 ... 6300 kPa 9.1 ... 914 psi	63 bar 6300 kPa 914 psi	67 bar 6.7MPa 972 psi	100 bar 10 MPa 1450 psi
HART	PROFIBUS PA/ FOUNDATION Fieldbus	Max. operating pressure MAWP (PS)	Max. perm. test pressure																						
Span	Nominal measuring range																								
0.01 ... 1 bar 1 ... 100 kPa 0.15 ... 14.5 psi	1 bar 100 kPa 14.5 psi	4 bar 400 kPa 58 psi	6 bar 600 kPa 87 psi)																						
0.04 ... 4 bar 4 ... 400 kPa 0.58 ... 58 psi	4 bar 400 kPa 58 psi	7 bar 0.7 MPa 102 psi	10 bar 1 MPa 145 psi																						
0.16 ... 16 bar 16 ... 1600 kPa 2.3 ... 232 psi	16 bar 1600 kPa 232 psi	21 bar 2.1 MPa 305 psi	32 bar 3.2 MPa 464 psi																						
0.63 ... 63 bar 63 ... 6300 kPa 9.1 ... 914 psi	63 bar 6300 kPa 914 psi	67 bar 6.7MPa 972 psi	100 bar 10 MPa 1450 psi																						
Lower measuring limit	100 mbar a/10 kPa a/1.45 psia																								
<ul style="list-style-type: none"> <li>Measuring cell with silicone oil filling</li> <li>Measuring cell with inert filling liquid</li> <li>Measuring cell with Neobee</li> </ul>	100 mbar a/10 kPa a/1.45 psia																								
Upper measuring limit	100 mbar a/10 kPa a/1.45 psia																								
	100 % of max. span																								
Input of absolute pressure, with front-flush diaphragm																									
Measured variable	Absolute pressure, front-flush																								
Span (continuously adjustable) or measuring range, max. operating pressure and max. test pressure	<table border="1"> <thead> <tr> <th>HART</th> <th>PROFIBUS PA/ FOUNDATION Fieldbus</th> <th>Max. operating pressure MAWP (PS)</th> <th>Max. perm. test pressure</th> </tr> </thead> <tbody> <tr> <td>Span</td> <td>Nominal measuring range</td> <td></td> <td></td> </tr> <tr> <td>43 ... 1300 mbar a 4.3 ... 130 kPa a 17 ... 525 inH<sub>2</sub>O a</td> <td>1300 mbar a 130 kPa a 525 inH<sub>2</sub>O a</td> <td>2.6 bar a 260 kPa a 37.7 psia</td> <td>10 bar a 1 MPa a 145 psia</td> </tr> <tr> <td>160 ... 5000 mbar a 16 ... 500 kPa a 2.32 ... 72.5 psia</td> <td>5000 mbar a 500 kPa a 72.5 psia</td> <td>10 bar a 1 MPa a 145 psia</td> <td>30 bar a 3 MPa a 435 psia</td> </tr> <tr> <td>1 ... 30 bar a 0.1 ... 3 MPa a 14.5 ... 435 psia</td> <td>30 bar a 3 MPa a 435 psia</td> <td>45 bar a 4.5 MPa a 653 psia</td> <td>100 bar a 10 MPa a 1450 psia</td> </tr> </tbody> </table>	HART	PROFIBUS PA/ FOUNDATION Fieldbus	Max. operating pressure MAWP (PS)	Max. perm. test pressure	Span	Nominal measuring range			43 ... 1300 mbar a 4.3 ... 130 kPa a 17 ... 525 inH <sub>2</sub> O a	1300 mbar a 130 kPa a 525 inH <sub>2</sub> O a	2.6 bar a 260 kPa a 37.7 psia	10 bar a 1 MPa a 145 psia	160 ... 5000 mbar a 16 ... 500 kPa a 2.32 ... 72.5 psia	5000 mbar a 500 kPa a 72.5 psia	10 bar a 1 MPa a 145 psia	30 bar a 3 MPa a 435 psia	1 ... 30 bar a 0.1 ... 3 MPa a 14.5 ... 435 psia	30 bar a 3 MPa a 435 psia	45 bar a 4.5 MPa a 653 psia	100 bar a 10 MPa a 1450 psia				
HART	PROFIBUS PA/ FOUNDATION Fieldbus	Max. operating pressure MAWP (PS)	Max. perm. test pressure																						
Span	Nominal measuring range																								
43 ... 1300 mbar a 4.3 ... 130 kPa a 17 ... 525 inH <sub>2</sub> O a	1300 mbar a 130 kPa a 525 inH <sub>2</sub> O a	2.6 bar a 260 kPa a 37.7 psia	10 bar a 1 MPa a 145 psia																						
160 ... 5000 mbar a 16 ... 500 kPa a 2.32 ... 72.5 psia	5000 mbar a 500 kPa a 72.5 psia	10 bar a 1 MPa a 145 psia	30 bar a 3 MPa a 435 psia																						
1 ... 30 bar a 0.1 ... 3 MPa a 14.5 ... 435 psia	30 bar a 3 MPa a 435 psia	45 bar a 4.5 MPa a 653 psia	100 bar a 10 MPa a 1450 psia																						
	Depending on the process connection, the span may differ from these values																								
Lower measuring limit	0 mbar a/0 kPa a/0 psia																								
Upper measuring limit	100 % of max. span																								
Output																									
Output signal	<table border="1"> <thead> <tr> <th>HART</th> <th>PROFIBUS PA/FOUNDATION Fieldbus</th> </tr> </thead> <tbody> <tr> <td>4 ... 20 mA</td> <td>Digital PROFIBUS PA and FOUNDATION Fieldbus signal</td> </tr> <tr> <td> <ul style="list-style-type: none"> <li>Lower limit (infinitely adjustable)</li> <li>Upper limit (infinitely adjustable)</li> </ul> </td> <td>-</td> </tr> <tr> <td>Load</td> <td>-</td> </tr> <tr> <td> <ul style="list-style-type: none"> <li>Without HART</li> <li>With HART</li> </ul> </td> <td>-</td> </tr> <tr> <td>Physical bus</td> <td>-</td> </tr> <tr> <td>Protection against polarity reversal</td> <td>IEC 61158-2</td> </tr> <tr> <td>Electrical damping (step width 0.1 s)</td> <td>Protected against short-circuit and polarity reversal. Each connection against the other with max. supply voltage.</td> </tr> <tr> <td></td> <td>Set to 2 s (0 ... 100 s)</td> </tr> </tbody> </table>	HART	PROFIBUS PA/FOUNDATION Fieldbus	4 ... 20 mA	Digital PROFIBUS PA and FOUNDATION Fieldbus signal	<ul style="list-style-type: none"> <li>Lower limit (infinitely adjustable)</li> <li>Upper limit (infinitely adjustable)</li> </ul>	-	Load	-	<ul style="list-style-type: none"> <li>Without HART</li> <li>With HART</li> </ul>	-	Physical bus	-	Protection against polarity reversal	IEC 61158-2	Electrical damping (step width 0.1 s)	Protected against short-circuit and polarity reversal. Each connection against the other with max. supply voltage.		Set to 2 s (0 ... 100 s)						
HART	PROFIBUS PA/FOUNDATION Fieldbus																								
4 ... 20 mA	Digital PROFIBUS PA and FOUNDATION Fieldbus signal																								
<ul style="list-style-type: none"> <li>Lower limit (infinitely adjustable)</li> <li>Upper limit (infinitely adjustable)</li> </ul>	-																								
Load	-																								
<ul style="list-style-type: none"> <li>Without HART</li> <li>With HART</li> </ul>	-																								
Physical bus	-																								
Protection against polarity reversal	IEC 61158-2																								
Electrical damping (step width 0.1 s)	Protected against short-circuit and polarity reversal. Each connection against the other with max. supply voltage.																								
	Set to 2 s (0 ... 100 s)																								

# Pressure Measurement

## Transmitters for applications with advanced requirements (Advanced)

### SITRANS P DS III for gauge/absolute pressure, with front-flush diaphragm

1

<b>SITRANS P DS III series for gauge and absolute pressure, with front-flush diaphragm</b>													
<b>Measuring accuracy</b> Reference conditions (All error data refer always refer to the set span)  Measuring span ratio r (spread, Turn-Down)  Error in measurement at limit setting incl. hysteresis and reproducibility  <ul style="list-style-type: none"> <li>• Linear characteristic</li> <li>- <math>r \leq 5</math></li> <li>- <math>5 &lt; r \leq 100</math></li> <li>- <math>r \leq 10</math></li> <li>- <math>10 &lt; r \leq 30</math></li> </ul> Influence of ambient temperature (in percent per 28 °C (50 °F))  Effect of ambient temperature (in pressure per temperature change)  <ul style="list-style-type: none"> <li>• Temperature difference between medium                temperature and ambient temperature</li> </ul> Long-term stability (temperature change $\pm 30$ °C ( $\pm 54$ °F))  Effect of mounting position (in pressure per change in angle)  Effect of auxiliary power supply (in percent per change in voltage)  Measuring value resolution for PROFIBUS PA and FOUNDATION Fieldbus	Acc. to IEC 60770-1  <ul style="list-style-type: none"> <li>• Increasing characteristic</li> <li>• Start-of-scale value 0 bar/kPa/psi</li> <li>• Stainless steel seal diaphragm</li> <li>• Silicone oil filling</li> <li>• Room temperature 25 °C (77 °F)</li> </ul> $r = \max. \text{measuring span/set measuring span or nom. pressure range}$  <table border="1" style="width: 100%; border-collapse: collapse;"> <thead> <tr> <th style="width: 50%; text-align: left;">Gauge pressure, front-flush</th> <th style="width: 50%; text-align: left;">Absolute pressure, front-flush</th> </tr> </thead> <tbody> <tr> <td><math>\leq 0.075 \%</math></td> <td>-</td> </tr> <tr> <td><math>\leq (0.005 \cdot r + 0.05) \%</math></td> <td>-</td> </tr> <tr> <td>-</td> <td><math>\leq 0.2 \%</math></td> </tr> <tr> <td>-</td> <td><math>\leq 0.4 \%</math></td> </tr> <tr> <td><math>\leq (0.08 \cdot r + 0.16) \%</math></td> <td><math>\leq (0.16 \cdot r + 0.24) \%</math></td> </tr> </tbody> </table>  3 mbar/0.3 kPa/0.04 psi per 10 K  $\leq (0.25 \cdot r) \%$ in 5 years  0.4 mbar/0.04 kPa/0.006 per 10° inclination (zero point correction is possible with position error compensation)  0.005 % per 1 V  $3 \cdot 10^{-5}$ of nominal measuring range	Gauge pressure, front-flush	Absolute pressure, front-flush	$\leq 0.075 \%$	-	$\leq (0.005 \cdot r + 0.05) \%$	-	-	$\leq 0.2 \%$	-	$\leq 0.4 \%$	$\leq (0.08 \cdot r + 0.16) \%$	$\leq (0.16 \cdot r + 0.24) \%$
Gauge pressure, front-flush	Absolute pressure, front-flush												
$\leq 0.075 \%$	-												
$\leq (0.005 \cdot r + 0.05) \%$	-												
-	$\leq 0.2 \%$												
-	$\leq 0.4 \%$												
$\leq (0.08 \cdot r + 0.16) \%$	$\leq (0.16 \cdot r + 0.24) \%$												
<b>Rated conditions</b>													
<u>Installation conditions</u>													
Ambient temperature  <ul style="list-style-type: none"> <li>• Measuring cell with silicone oil</li> <li>• Measuring cell with Neobee oil (with front-flush diaphragm)</li> <li>• Measuring cell with inert liquid</li> <li>• Transmitter</li> <li>• Display readable</li> <li>• Storage temperature</li> </ul> Climatic class  <ul style="list-style-type: none"> <li>• Condensation</li> </ul> Degree of protection (to IEC 60529)  Electromagnetic Compatibility  <ul style="list-style-type: none"> <li>• Emitted interference and interference immunity</li> </ul> <u>Medium conditions</u>	Observe the temperature class in areas subject to explosion hazard.  -40 ... +85 °C (-40 ... +185 °F) -10 ... +85 °C (14 ... +185 °F) -40 ... +85 °C (-40 ... +185 °F) -40 ... +85 °C (-40 ... +185 °F) -30 ... +85 °C (-22 ... +185 °F) -50 ... +85 °C (-58 ... +185 °F) (in the case of Neobee: -20 ... +85 °C (-4 ... +185 °F)) (for high temperature oil: -10 ... +85 °C (14 ... 185 °F))  Relative humidity 0 ... 100 % Condensation permissible, suitable for use in the tropics  IP66 (optional IP66/IP68), NEMA 4X  Acc. to IEC 61326 and NAMUR NE 21  The max. medium temperature of the front-flush process connections is to be taken into account in accordance with the relevant connection standards (e. g. DIN 32676, DIN 11851 etc.).  Temperature of medium  <ul style="list-style-type: none"> <li>• Measuring cell with silicone oil</li> <li>• Measuring cell with silicone oil (with front-flush diaphragm)</li> <li>• Measuring cell with Neobee oil (with front-flush diaphragm)</li> <li>• Measuring cell with silicone oil, with temperature decoupler                (only for gauge pressure version with front-flush diaphragm)</li> <li>• Measuring cell with Neobee oil, with temp. decoupler (only for                gauge pressure version with flush-mounted diaphragm)</li> <li>• Measuring cell with inert filling liquid</li> <li>• Measuring cell with high-temperature oil (only for gauge pres-                sure version with front-flush diaphragm)</li> </ul>												
Temperature of medium  <ul style="list-style-type: none"> <li>• Measuring cell with silicone oil</li> <li>• Measuring cell with silicone oil (with front-flush diaphragm)</li> <li>• Measuring cell with Neobee oil (with front-flush diaphragm)</li> <li>• Measuring cell with silicone oil, with temperature decoupler                (only for gauge pressure version with front-flush diaphragm)</li> <li>• Measuring cell with Neobee oil, with temp. decoupler (only for                gauge pressure version with flush-mounted diaphragm)</li> <li>• Measuring cell with inert filling liquid</li> <li>• Measuring cell with high-temperature oil (only for gauge pres-                sure version with front-flush diaphragm)</li> </ul>	-40 ... +100 °C (-40 ... +212 °F) -40 ... +150 °C (-40 ... +302 °F) -10 ... +150 °C (14 ... 302 °F) -40 ... +200 °C (-40 ... +392 °F) -10 ... +200 °C (14 ... 392 °F) -20 ... +100 °C (-4 ... +212 °F) -10 ... +250 °C (14 ... 482 °F)												

## Pressure Measurement

Transmitters for applications with advanced requirements (Advanced)

### SITRANS P DS III for gauge/absolute pressure, with front-flush diaphragm

#### SITRANS P DS III series for gauge and absolute pressure, with front-flush diaphragm

##### Design

Weight (without options)	≈ 1.5 kg (≈ 3.3 lb)
Enclosure material	Low-copper die-cast aluminum, GD-AISI12 or stainless steel precision casting, mat. no. 1.4408
Wetted parts materials	Stainless steel, mat. no. 1.4404/316L or Hastelloy C276, mat. no. 2.4819
Measuring cell filling	Silicone oil or inert filling liquid
Process connection	<ul style="list-style-type: none"> <li>• Flanges as per EN and ASME</li> <li>• F&amp;B and pharmaceutical flanges</li> </ul>
Surface quality touched-by-media	$R_a$ -values $\leq 0.8 \mu\text{m}$ (32 $\mu\text{-inch}$ )/welds $R_{a1} \leq 1.6 \mu\text{m}$ (64 $\mu\text{-inch}$ ) (Process connections acc. to 3A; $R_a$ -values $\leq 0.8 \mu\text{m}$ (32 $\mu\text{-inch}$ )/welds $R_a \leq 0.8 \mu\text{m}$ (32 $\mu\text{-inch}$ ))

##### Power supply $U_H$

	HART	PROFIBUS PA/FOUNDATION Fieldbus
Terminal voltage on transmitter	10.5 ... 45 V DC 10.5 ... 30 V DC in intrinsically-safe mode	-
Power supply	-	Supplied through bus
Separate 24 V power supply necessary	-	No
Bus voltage		
• Not Ex	-	9 ... 32 V
• With intrinsically-safe operation	-	9 ... 24 V
Current consumption		
• Basic current (max.)	-	12.5 mA
• Start-up current $\leq$ basic current	-	Yes
• Max. current in event of fault	-	15.5 mA
Fault disconnection electronics (FDE) available	-	Yes

**SITRANS P DS III series for gauge and absolute pressure, with front-flush diaphragm****Certificates and approvals**

Classification according to PED 2014/68/EU	For gases of fluid group 1 and liquids of fluid group 1; complies with requirements of article 4, paragraph 3 (sound engineering practice)	
Explosion protection		
• Intrinsic safety "i"	PTB 13 ATEX 2007 X	
- Marking	Ex II 1/2 G Ex ia/ib IIC T4/T5/T6 Ga/Gb	
- Permissible ambient temperature	-40 ... +85 °C (-40 ... +185 °F) temperature class T4; -40 ... +70 °C (-40 ... +158 °F) temperature class T5; -40 ... +60 °C (-40 ... +140 °F) temperature class T6	
- Connection	To certified intrinsically-safe circuits with peak values: $U_i = 30 \text{ V}$ , $I_i = 100 \text{ mA}$ , $P_i = 750 \text{ mW}$ ; $R_i = 300 \Omega$	FISCO supply unit: $U_o = 17.5 \text{ V}$ , $I_o = 380 \text{ mA}$ , $P_o = 5.32 \text{ W}$ Linear barrier: $U_o = 24 \text{ V}$ , $I_o = 250 \text{ mA}$ , $P_o = 1.2 \text{ W}$ $L_i = 7 \mu\text{H}$ , $C_i = 1.1 \text{ nF}$
- Effective internal inductance/capacitance	$L_i = 0.4 \text{ mH}$ , $C_i = 6 \text{ nF}$	
• Explosion-proof "d"	PTB 99 ATEX 1160	
- Marking	Ex II 1/2 G Ex d IIC T4/T6 Gb	
- Permissible ambient temperature	-40 ... +85 °C (-40 ... +185 °F) temperature class T4; -40 ... +60 °C (-40 ... +140 °F) temperature class T6	
- Connection	To circuits with values: $U_H = 10.5 \dots 45 \text{ V DC}$	To circuits with values: $U_H = 9 \dots 32 \text{ V DC}$
• Dust explosion protection for zone 20	PTB 01 ATEX 2055	
- Marking	Ex II 1 D Ex ta IIIC T120°C Da Ex II 1/2 D Ex ta/tb IIIC T120°C Da/Db	
- Permissible ambient temperature	-40 ... +85 °C (-40 ... +185 °F)	
- Max. surface temperature	120 °C (248 °F)	
- Connection	To certified intrinsically-safe circuits with peak values: $U_i = 30 \text{ V}$ , $I_i = 100 \text{ mA}$ , $P_i = 750 \text{ mW}$ , $R_i = 300 \Omega$	FISCO supply unit: $U_o = 17.5 \text{ V}$ , $I_o = 380 \text{ mA}$ , $P_o = 5.32 \text{ W}$ Linear barrier: $U_o = 24 \text{ V}$ , $I_o = 250 \text{ mA}$ , $P_o = 1 \text{ W}$ $L_i = 7 \mu\text{H}$ , $C_i = 1.1 \text{ nF}$
- Effective internal inductance/capacitance	$L_i = 0.4 \text{ mH}$ , $C_i = 6 \text{ nF}$	
• Dust explosion protection for zone 21/22	Ex II 2 D Ex tb IIIC T120°C Db	
- Marking	Ex II 2 D IP65 T 120 °C	
- Connection	To circuits with values: $U_H = 10.5 \dots 45 \text{ V DC}$ ; $P_{\max} = 1.2 \text{ W}$	To circuits with values: $U_H = 9 \dots 32 \text{ V DC}$ ; $P_{\max} = 1 \text{ W}$
• Type of protection "n" (zone 2)	PTB 13 ATEX 2007 X	
- Marking	Ex II 2/3 G Ex nA II T4/T5/T6 Gc Ex II 2/3 G Ex ic IIC T4/T5/T6 Gc	
- Connection (Ex nA)	$U_m = 45 \text{ V}$	
- Connections (Ex ic)	To circuits with values: $U_i = 45 \text{ V}$	$U_m = 32 \text{ V}$ FISCO supply unit ic: $U_o = 17.5 \text{ V}$ , $I_o = 570 \text{ mA}$ Linear barrier: $U_o = 32 \text{ V}$ , $I_o = 132 \text{ mA}$ , $P_o = 1 \text{ W}$ $L_i = 7 \mu\text{H}$ , $C_i = 1.1 \text{ nF}$
- Effective internal inductance/capacitance	$L_i = 0.4 \text{ mH}$ , $C_i = 6 \text{ nF}$	
• Explosion protection acc. to FM	Certificate of Compliance 3008490	
- Identification (XP/DIP) or (IS); (NI)	CL I, DIV 1, GP ABCD T4...T6; CL II, DIV 1, GP EFG; CL III; CL I, ZN 0/1 AEx ia IIC T4...T6; CL I, DIV 2, GP ABCD T4...T6; CL II, DIV 2, GP FG; CL III	
• Explosion protection to CSA	Certificate of Compliance 1153651	
- Identification (XP/DIP) or (IS)	CL I, DIV 1, GP ABCD T4...T6; CL II, DIV 1, GP EFG; CL III; Ex ia IIC T4...T6; CL I, DIV 2, GP ABCD T4...T6; CL II, DIV 2, GP FG; CL III	

**Hygiene version**

In the case of SITRANS P DSIII with 7MF413x front-flush diaphragm, selected connections comply with the requirements of EHEDG.

## Pressure Measurement

Transmitters for applications with advanced requirements (Advanced)

### SITRANS P DS III for gauge/absolute pressure, with front-flush diaphragm

HART communication		FOUNDATION Fieldbus communication	
HART	230 ... 1100 Ω	Function blocks	3 function blocks analog input, 1 function block PID
Protocol	HART Version 5.x	• Analog input	Yes, linearly rising or falling characteristic
Software for computer	SIMATIC PDM	- Adaptation to customer-specific process variables	0 ... 100 s
<b>PROFIBUS PA communication</b>		- Electrical damping, adjustable	Output/input (can be locked within the device with a bridge)
Simultaneous communication with master class 2 (max.)	4	- Simulation function	parameterizable (last good value, substitute value, incorrect value)
The address can be set using	Configuration tool or local operation (standard setting address 126)	- Failure mode	Yes, one upper and lower warning limit and one alarm limit respectively
Cyclic data usage		- Limit monitoring	Yes
• Output byte	5 (one measured value) or 10 (two measured values)	- Square-rooted characteristic for flow measurement	Standard FOUNDATION Fieldbus function block
• Input byte	0, 1, or 2 (register operating mode and reset function for metering)	• PID	1 resource block
Internal preprocessing		• Physical block	1 transducer block Pressure with calibration, 1 transducer block LCD
Device profile	PROFIBUS PA Profile for Process Control Devices Version 3.0, class B	Transducer blocks	
Function blocks	2	• Pressure transducer block	
• Analog input		- Can be calibrated by applying two pressures	Yes
- Adaptation to customer-specific process variables	Yes, linearly rising or falling characteristic	- Monitoring of sensor limits	Yes
- Electrical damping, adjustable	0 ... 100 s	- Simulation function: Measured pressure value, sensor temperature and electronics temperature	Constant value or over parameterizable ramp function
- Simulation function	Input /Output		
- Failure mode	parameterizable (last good value, substitute value, incorrect value)		
- Limit monitoring	Yes, one upper and lower warning limit and one alarm limit respectively		
• Register (totalizer)	Can be reset, preset, optional direction of counting, simulation function of register output		
- Failure mode	parameterizable (summation with last good value, continuous summation, summation with incorrect value)		
- Limit monitoring	One upper and lower warning limit and one alarm limit respectively		
• Physical block	1		
Transducer blocks	2		
• Pressure transducer block			
- Can be calibrated by applying two pressures	Yes		
- Monitoring of sensor limits	Yes		
- Specification of a container characteristic with	Max. 30 nodes		
- Square-rooted characteristic for flow measurement	Yes		
- Gradual volume suppression and implementation point of square-root extraction	Parameterizable		
- Simulation function for measured pressure value and sensor temperature	Constant value or over parameterizable ramp function		

## SITRANS P DS III for gauge/absolute pressure, with front-flush diaphragm

Selection and Ordering data	Article No.	Selection and Ordering data	Article No.
<b>Pressure transmitter for gauge and absolute pressure, front-flush diaphragm, SITRANS P DS III HART</b>	<b>7MF4133-</b>	<b>Pressure transmitter for gauge and absolute pressure, front-flush diaphragm, SITRANS P DS III HART</b>	<b>7MF4133-</b>
<a href="#">Click on the Article No. for the online configuration in the PIA Life Cycle Portal.</a>			
<b>Measuring cell filling</b>		<b>Display</b>	
Silicone oil	normal	• Without display	0
Inert liquid	grease-free to cleanliness level 2	• Without visible display (display concealed, setting: mA)	1
FDA compliant fill fluid		• With visible display (setting: mA)	6
• Neobee oil	normal	• With customer-specific display (setting as specified, Order code "Y21" or "Y22" required)	7
<b>Measuring cell cleaning</b>			
0.01 ... 1 bar (0.15 ... 14.5 psi)	B	<b>Power supply units</b> see Chap. 7 "Supplementary Components".	
0.04 ... 4 bar (0.58 ... 58 psi)	C	A quick-start guide is included in the scope of delivery of the device.	
0.16 ... 16 bar (2.32 ... 232 psi)	D		
0.63 ... 63 bar (9.14 ... 914 psi)	E	1) Not with temperature decoupler P00 and P10, not for process connections R02, R04, R10 and R11, and can only be ordered in conjunction with silicone oil.	
43 ... 1300 mbar a <sup>1)</sup> (0.62 ... 18.85 psia <sup>1)</sup> )	S	2) Only available for flanges with options M..., N... and Q..	
0.16 ... 5 bar a <sup>1)</sup> (0.7 ... 72.5 psia <sup>1)</sup> )	T	3) Without cable gland, with blanking plug	
1 ... 30 bar a <sup>1)</sup> (4.35 ... 435 psia <sup>1)</sup> )	U	4) Configurations with HAN and M12 connectors are only available in Ex ic.	
<b>Wetted parts materials</b>		5) Explosion protection acc. to FM/CSA: suitable for installations according to NEC 500/505.	
Seal diaphragm	Connection shank	6) Only in connection with IP66.	
Stainless steel	Stainless steel	7) With enclosed cable gland Ex ia and blanking plug.	
Hastelloy <sup>2)</sup>	Stainless steel	8) Only in connection with Ex approval A, B or E.	
<b>Process connection</b>		9) Only in connection with Ex approval A, B, E or F.	
• Flange version with Order code M..., N..., R.. or Q..	7	10) M12 delivered without cable socket	
<b>Non-wetted parts materials</b>			
• Housing made of die-cast aluminium	0		
• Housing stainless steel precision casting	3		
<b>Version</b>			
• Standard version, German plate inscription, setting for pressure unit: bar	1		
• International version, English plate inscription, setting for pressure unit: bar	2		
• Chinese version, English plate inscription, setting for pressure unit: Pascal	3		
All versions include DVD with compact operating instructions in various EU languages.			
<b>Explosion protection</b>			
• None	A		
• With ATEX, Type of protection:			
- "Intrinsic safety (Ex ia)"	B		
- "Explosion-proof (Ex d)" <sup>3)</sup>	D		
- „Ex nA/ic (Zone 2)" <sup>4)</sup>	E		
• FM + CSA intrinsic safe (is) <sup>5)</sup>	F		
• FM + CSA (is + ep) + Ex ia + Ex d (ATEX) + Zone 1D/2D <sup>5)6)7)</sup>	S		
• With FM + CSA, Type of protection:			
- "Intrinsic Safe and Explosion Proof (is + xp)" <sup>3)5)</sup>	NC		
<b>Electrical connection/cable entry</b>			
• Inner thread M20 x 1.5	B		
• Female thread ½-14 NPT	C		
• Han 7D plug (plastic housing) incl. mating connector <sup>8)</sup>	D		
• M12 connectors (stainless steel) <sup>9) 10)</sup>	F		

## Pressure Measurement

Transmitters for applications with advanced requirements (Advanced)

### SITRANS P DS III for gauge/absolute pressure, with front-flush diaphragm

Selection and Ordering data	Article No.
<b>Pressure transmitter P for gauge and absolute pressure, front-flush diaphragm:</b>	
<b>SITRANS P DS III with PROFIBUS PA (PA)</b>	7 M F 4 1 3 4 -
<b>SITRANS P DS III with FOUNDATION Fieldbus (FF)</b>	7 M F 4 1 3 5 -
↗ Click on the Article No. for the online configuration in the PIA Life Cycle Portal.	
<b>Measuring cell filling</b>	
Silicone oil	1
Inert liquid	3
FDA compliant fill fluid	
• Neobee oil	4
<b>Measuring cell cleaning</b>	
normal	
grease-free to cleanliness level 2	
<b>Nominal measuring range</b>	
1 bar (14.5 psi)	B
4 bar (58 psi)	C
16 bar (232 psi)	D
63 bar (914 psi)	E
1300 mbar a <sup>1)</sup> (18.85 psia) <sup>1)</sup>	S
5 bar a <sup>1)</sup> (72.5 psia) <sup>1)</sup>	T
30 bar a <sup>1)</sup> (435 psia) <sup>1)</sup>	U
<b>Wetted parts materials</b>	
Seal diaphragm	
Connection shank	
Stainless steel	A
Hastelloy <sup>2)</sup>	B
<b>Process connection</b>	
• Flange version with Order code M.., N.., R.. or Q..	7
<b>Non-wetted parts materials</b>	
• Housing made of die-cast aluminium	0
• Housing stainless steel precision casting	3
<b>Version</b>	
• Standard version, German plate inscription, setting for pressure unit: bar	1
• International version, English plate inscription, setting for pressure unit: bar	2
• Chinese version, English plate inscription, setting for pressure unit: Pascal	3
All versions include DVD with compact operating instructions in various EU languages.	
<b>Explosion protection</b>	
• None	A
• With ATEX, Type of protection:	
- "Intrinsic safety (Ex ia)"	B
- "Explosion-proof (Ex d)" <sup>3)</sup>	D
- „Ex nA/ic (Zone 2)" <sup>4)</sup>	E
• FM + CSA intrinsic safe (is) <sup>5)</sup>	F
• FM + CSA (is + ep) + Ex ia + Ex d (ATEX) + Zone 1D/2D <sup>5)6)7)</sup>	S
• With FM + CSA, Type of protection:	
- "Intrinsic Safe and Explosion Proof (is + xp)" <sup>3)5)</sup> (available soon)	NC
<b>Electrical connection/cable entry</b>	
• Screwed gland M20 x 1.5	B
• Screwed gland ½-14 NPT	C
• M12 connectors (stainless steel) <sup>8) 9)</sup>	F

Selection and Ordering data	Article No.
<b>Pressure transmitter P for gauge and absolute pressure, front-flush diaphragm:</b>	
<b>SITRANS P DS III with PROFIBUS PA (PA)</b>	7 M F 4 1 3 4 -
<b>SITRANS P DS III with FOUNDATION Fieldbus (FF)</b>	7 M F 4 1 3 5 -
↗ Click on the Article No. for the online configuration in the PIA Life Cycle Portal.	
<b>Display</b>	
• Without display	0
• Without visible display (display concealed, setting: bar)	1
• With visible display (setting: bar)	6
• With customer-specific display (setting as specified, Order code "Y21" required)	7
A quick-start guide is included in the scope of delivery of the device.	
1) Not with temperature decoupler P00 and P10, not for process connections R01, R02, R04, R10 and R11, and can only be ordered in conjunction with silicone oil.	
2) Only available for flanges with options M.., N.. and Q.	
3) Without cable gland, with blanking plug	
4) Configurations with HAN and M12 connectors are only available in Ex ic.	
5) Explosion protection acc. to FM/CSA: suitable for installations according to NEC 500/505.	
6) Only in connection with IP66.	
7) With enclosed cable gland Ex ia and blanking plug.	
8) Only in connection with Ex approval A, B, E or F.	
9) M12 delivered without cable socket	

## Pressure Measurement

### Transmitters for applications with advanced requirements (Advanced)

#### SITRANS P DS III for gauge/absolute pressure, with front-flush diaphragm

1

Selection and Ordering data	Order code			
<b>Further designs</b> Add "-Z" to Article No. and specify Order code.		HART	PA	FF
<b>Plug</b>				
• Han 7D (metal)	A30	✓		
• Han 8D (instead of Han 7D)	A31	✓		
• Angled	A32	✓		
• Han 8D (metal)	A33	✓		
<b>Cable sockets for M12 connectors (metal (CuZn))</b>	A50	✓	✓	✓
<b>Rating plate inscription</b> (instead of German)				
• English	B11	✓	✓	✓
• French	B12	✓	✓	✓
• Spanish	B13	✓	✓	✓
• Italian	B14	✓	✓	✓
• Cyrillic (russian)	B16	✓	✓	✓
<b>English rating plate</b>	B21	✓	✓	✓
Pressure units in inH <sub>2</sub> O and/or psi				
<b>Quality Inspection Certificate (5-point characteristic curve test) according to IEC 60770-2</b>	C11	✓	✓	✓
<b>Inspection certificate</b> Acc. to EN 10204-3.1	C12	✓	✓	✓
<b>Factory certificate</b> Acc. to EN 10204-2.2	C14	✓	✓	✓
<b>Functional safety (SIL2)</b> Devices suitable for use according to IEC 61508 and IEC 61511. Includes SIL conformity declaration	C20	✓		
<b>Functional safety (PROFIsafe) Certificate and PROFIsafe protocol</b>	C21 <sup>1)</sup>		✓	
<b>Functional safety (SIL2/3)</b> Devices suitable for use according to IEC 61508 and IEC 61511. Includes SIL conformity declaration	C23	✓		
<b>PED for Russia with initial calibration mark</b>	C99	✓	✓	✓
<b>Setting of the upper saturation limit of the output signal to 22.0 mA</b>	D05	✓		
<b>Degree of protection IP66/IP68</b> (only for M20x1.5 and 1/2"-14 NPT)	D12	✓	✓	✓
<b>Capri cable gland 4F CrNi and clamping device (848699 + 810634) included</b>	D59	✓	✓	✓
<b>Oxygen application</b> (In the case of oxygen measurement and inert liquid max. 100 bar (1450 psi) at 60°C (140 °F))	E10	✓	✓	✓
<b>Export approval Korea</b>	E11	✓	✓	✓
<b>CRN approval Canada<sup>2)</sup></b> (Canadian Registration Number)	E22	✓	✓	✓
<b>Dual seal</b>	E24	✓	✓	✓
<b>Explosion-proof "Intrinsic safety" (Ex ia) to INMETRO (Brazil)</b> (only for transmitter 7MF4...-.....-B..)	E25 <sup>3)</sup>	✓	✓	✓
<b>"Flameproof" explosion protection according to INMETRO (Brazil)</b> (only for transmitter 7MF4...-.....-D..)	E26 <sup>3)</sup>	✓	✓	✓
<b>Explosion-proof "Intrinsic safety" (Ex ia + Ex d) to INMETRO (Brazil)</b> (only for transmitter 7MF4...-.....-P..)	E28 <sup>3)</sup>	✓	✓	
<b>Ex Approval IEC Ex (Ex ia)</b> (only for transmitter 7MF4...-.....-B..)	E45 <sup>3)</sup>	✓	✓	✓
<b>Ex Approval IEC Ex (Ex d)</b> (only for transmitter 7MF4...-.....-D..)	E46 <sup>3)</sup>	✓	✓	✓
Selection and Ordering data	Order code			
<b>Further designs</b> Add "-Z" to Article No. and specify Order code.		HART	PA	FF
<b>Explosion-proof "Intrinsic safety" to NEPSI (China)</b> (only for transmitter 7MF4...-.....-B..)	E55 <sup>3)</sup>	✓	✓	✓
<b>Explosion protection "Explosion-proof" to NEPSI (China)</b> (only for transmitter 7MF4...-.....-D..)	E56 <sup>3)</sup>	✓	✓	✓
<b>Ex protection "Zone 2" to NEPSI (China)</b> (only for transmitter 7MF4...-.....-E..)	E57 <sup>3)</sup>	✓	✓	✓
<b>Ex protection „Ex ia“, „Ex d“ and „Zone 2“ to NEPSI (China)</b> (only for transmitter 7MF4...-.....-R..)	E58 <sup>3)</sup>	✓	✓	✓
<b>"Intrinsic safety" and "Explosion-proof" explosion protection acc. to Kosha (Korea)</b> (only for transmitter 7MF4...-.....-[B, D]..-Z + E11)	E70 <sup>3)</sup>	✓	✓	✓
<b>Ex-protection Ex ia according to EAC Ex (Russia)</b>	E80	✓	✓	✓
<b>Ex-protection Ex d according to EAC Ex (Russia)</b>	E81	✓	✓	✓
<b>Ex-protection Ex nA/ic (Zone 2) according to EAC Ex (Russia)</b>	E82	✓	✓	✓
<b>Ex-protection Ex ia + Ex d + Zone 1D/2D according to EAC Ex (Russia)</b>	E83	✓	✓	✓
<b>Two coats of lacquer on casing and cover (PU on epoxy)</b>	G10	✓	✓	✓
<b>Transient protector 6 kV (lightning protection)</b>	J01	✓	✓	✓
<b>Flanges to EN 1092-1, Form B1</b>				
• DN 25, PN 40 <sup>4)</sup>	M11	✓	✓	✓
• DN 40, PN 40	M13	✓	✓	✓
• DN 40, PN 100	M23	✓	✓	✓
• DN 50, PN 16	M04	✓	✓	✓
• DN 50, PN 40	M14	✓	✓	✓
• DN 80, PN 16	M06	✓	✓	✓
• DN 80, PN 40	M16	✓	✓	✓
<b>Flanges to ASME B16.5</b>				
• Stainless steel flange 1" class 150 <sup>4)</sup>	M40	✓	✓	✓
• Stainless steel flange 1½" class 150	M41	✓	✓	✓
• Stainless steel flange 2" class 150	M42	✓	✓	✓
• Stainless steel flange 3" class 150	M43	✓	✓	✓
• Stainless steel flange 4" class 150	M44	✓	✓	✓
• Stainless steel flange 1½" class 300	M46	✓	✓	✓
• Stainless steel flange 2" class 300	M47	✓	✓	✓
• Stainless steel flange 3" class 300	M48	✓	✓	✓
• Stainless steel flange 4" class 300	M49	✓	✓	✓
<b>Threaded connector to DIN 3852-2, form A, thread to ISO 228</b>				
• G ¾"-A, front-flush <sup>5)</sup>	R01	✓	✓	✓
• G 1"-A, front-flush <sup>5)</sup>	R02	✓	✓	✓
• G 2"-A, front-flush	R04	✓	✓	✓
<b>Tank connection<sup>6)</sup></b> Sealing is included in delivery				
• TG 52/50, PN 40	R10	✓	✓	✓
• TG 52/150, PN 40	R11	✓	✓	✓



## Pressure Measurement

Transmitters for applications with advanced requirements (Advanced)

### SITRANS P DS III for gauge/absolute pressure, with front-flush diaphragm

Selection and Ordering data	Order code			Selection and Ordering data	Order code		
<i>Further designs</i> Add "-Z" to Article No. and specify Order code.	HART	PA	FF	<i>Further designs</i> Add "-Z" to Article No. and specify Order code.	HART	PA	FF
<b>Sanitary process connection according DIN 11851 (Dairy connection with slotted union nut)</b>				<b>Sanitary process connection to NEUMO Bio-Connect clamp connection</b> EHEDG compliant			
• DN 50, PN 25	N04	✓	✓	• DN 50, PN 16	Q39	✓	✓
• DN 80, PN 25	N06	✓	✓	• DN 65, PN 10	Q40	✓	✓
<b>Tri-Clamp connection according DIN 32676/ISO 2852</b>				• DN 80, PN 10	Q41	✓	✓
• DN 50/2", PN 16	N14	✓	✓	• DN 100, PN 10	Q42	✓	✓
• DN 65/3", PN 10	N15	✓	✓	• DN 2½", PN 16	Q48	✓	✓
<b>Varivent connection</b> EHEDG compliant				• DN 3", PN 10	Q49	✓	✓
• Type N = 68 for Varivent housing DN 40 ... 125 and 1½" ... 6", PN 40	N28	✓	✓	• DN 4", PN 10	Q50	✓	✓
<b>Temperature decoupler up to 200 °C<sup>7)</sup></b> for version with front-flush diaphragm	P00	✓	✓	<b>Bio-Control sanitary process connection</b> EHEDG compliant <sup>8)</sup>			
<b>Sanitary process connection to DRD</b>				• DN 50, PN 16	Q53	✓	✓
• DN 50, PN 40	M32	✓	✓	• DN 65, PN 16	Q54	✓	✓
<b>SMS socket with union nut</b>				<b>Sanitary process connection to NEUMO Bio-Connect S flange connection</b> EHEDG compliant			
• 2"	M67	✓	✓	• DN 2", PN 16	Q72	✓	✓
• 2½"	M68	✓	✓	<b>Aseptic threaded socket to DIN 11864-1 Form A</b>			
• 3"	M69	✓	✓	EHEDG compliant			
<b>SMS threaded socket</b>				• DN 50, PN 25	N33	✓	✓
• 2"	M73	✓	✓	• DN 65, PN 25	N34	✓	✓
• 2½"	M74	✓	✓	• DN 80, PN 25	N35	✓	✓
• 3"	M75	✓	✓	• DN 100, PN 25	N36	✓	✓
<b>IDF socket with union nut ISO 2853</b>				<b>Aseptic flange with notch to DIN 11864-2 Form A</b>			
• 2"	M82	✓	✓	EHEDG compliant			
• 2½"	M83	✓	✓	• DN 50, PN 16	N43	✓	✓
• 3"	M84	✓	✓	• DN 65, PN 16	N44	✓	✓
<b>IDF threaded socket ISO 2853</b>				• DN 80, PN 16	N45	✓	✓
• 2"	M92	✓	✓	• DN 100, PN 16	N46	✓	✓
• 2½"	M93	✓	✓	<b>Aseptic flange with groove to DIN 11864-2 Form A</b> EHEDG compliant			
• 3"	M94	✓	✓	• DN 50, PN 16	N43 + P11	✓	✓
<b>Sanitary process connection to NEUMO Bio-Connect screw connection</b> EHEDG compliant				• DN 65, PN 16	N44 + P11	✓	✓
• DN 50, PN 16	Q05	✓	✓	• DN 80, PN 16	N45 + P11	✓	✓
• DN 65, PN 16	Q06	✓	✓	• DN 100, PN 16	N46 + P11	✓	✓
• DN 80, PN 16	Q07	✓	✓	<b>Aseptic clamp with groove to DIN 11864-3 Form A</b>			
• DN 100, PN 16	Q08	✓	✓	EHEDG compliant			
• DN 2", PN 16	Q13	✓	✓	• DN 50, PN 25	N53	✓	✓
• DN 2½", PN 16	Q14	✓	✓	• DN 65, PN 25	N54	✓	✓
• DN 3", PN 16	Q15	✓	✓	• DN 80, PN 16	N55	✓	✓
• DN 4", PN 16	Q16	✓	✓	• DN 100, PN 16	N56	✓	✓
<b>Sanitary process connection to NEUMO Bio-Connect flange connection</b> EHEDG compliant							
• DN 50, PN 16	Q23	✓	✓				
• DN 65, PN 16	Q24	✓	✓				
• DN 80, PN 16	Q25	✓	✓				
• DN 100, PN 16	Q26	✓	✓				
• DN 2", PN 16	Q31	✓	✓				
• DN 2½", PN 16	Q32	✓	✓				
• DN 3", PN 16	Q33	✓	✓				
• DN 4", PN 16	Q34	✓	✓				

1) Profisafe transmitters can only be operated with the S7 F Systems V6.1 configuration software in combination with S7-400H.

2) Cannot be ordered with remote seal.

3) Option does not include ATEX approval, but instead includes only the country-specific approval.

4) Special seal in Viton included in the scope of delivery.  
FKM; temperature range -20 ... +200 °C (-4 ... +392 °C)

5) Cannot be combined with Order codes P00 and P10. Can only be ordered with silicone oil measuring cell filling.

6) The weldable socket can be ordered under accessories.

7) 3A and EHEDG compliant. The maximum permissible temperatures of the medium depend on the respective cell fillings (see medium conditions).

8) 3A compliance ensured only when 3A compliant sealing rings are used.

Selection and Ordering data	Order code		
<i>Additional data</i>	HART	PA	FF
Please add <b>"-Z"</b> to Article No. and specify Order code(s) and plain text.			
<b>Measuring range to be set</b> Specify in plain text (max. 5 characters): Y01: ... up to ... mbar, bar, kPa, MPa, psi	Y01	✓	✓ <sup>1)</sup>
<b>Stainless steel tag plate and entry in device variable (measuring point description)</b> Max. 16 characters, specify in plain text: Y15: .....	Y15	✓	✓
<b>Measuring point text (entry in device variable)</b> Max. 27 characters, specify in plain text: Y16: .....	Y16	✓	✓
<b>Entry of HART address (TAG)</b> Max. 8 characters, specify in plain text: Y17: .....	Y17	✓	
<b>Setting of pressure indicator in pressure units</b> Specify in plain text (standard setting: bar): Y21: mbar, bar, kPa, MPa, psi, ... Note: The following pressure units can be selected: bar, mbar, mm H <sub>2</sub> O <sup>1)</sup> , inH <sub>2</sub> O <sup>1)</sup> , ftH <sub>2</sub> O <sup>1)</sup> , mmHG, inHG, psi, Pa, kPa, MPa, g/cm <sup>2</sup> , kg/cm <sup>2</sup> , Torr, ATM or % <sup>1)</sup> ref. temperature 20 °C	Y21	✓	✓
<b>Setting of pressure indication in non-pressure units<sup>2)</sup></b> Specify in plain text: Y22: ..... up to ..... l/min, m <sup>3</sup> /h, m, USgpm, ... (specification of measuring range in pressure units "Y01" is essential, unit with max. 5 characters)	Y22 + Y01	✓	
<b>Preset bus address</b> possible between 1 and 126 Specify in plain text: Y25: .....	Y25		✓
<b>Damping adjustment in seconds (0 ... 100 s)</b>	Y30	✓	✓

Only Y01, Y15, Y16, Y17, Y21, Y22, Y25 and D05 can be factory preset

✓ = available

#### ordering example

Item line: 7MF4133-1DB20-1AB7-Z  
B line: A22 + Y01 + Y21  
C line: Y01: 1 ... 10 bar (14.5 ... 145 psi)  
C line: Y21: bar (psi)

<sup>1)</sup> Measuring accuracies for PROFIBUS PA transmitters with Option Y01 are calculated in the same way as for HART devices.

<sup>2)</sup> Preset values can only be changed over SIMATIC PDM.

## Pressure Measurement

Transmitters for applications with advanced requirements (Advanced)

SITRANS P DS III for gauge/absolute pressure, with front-flush diaphragm

### Dimensional drawings

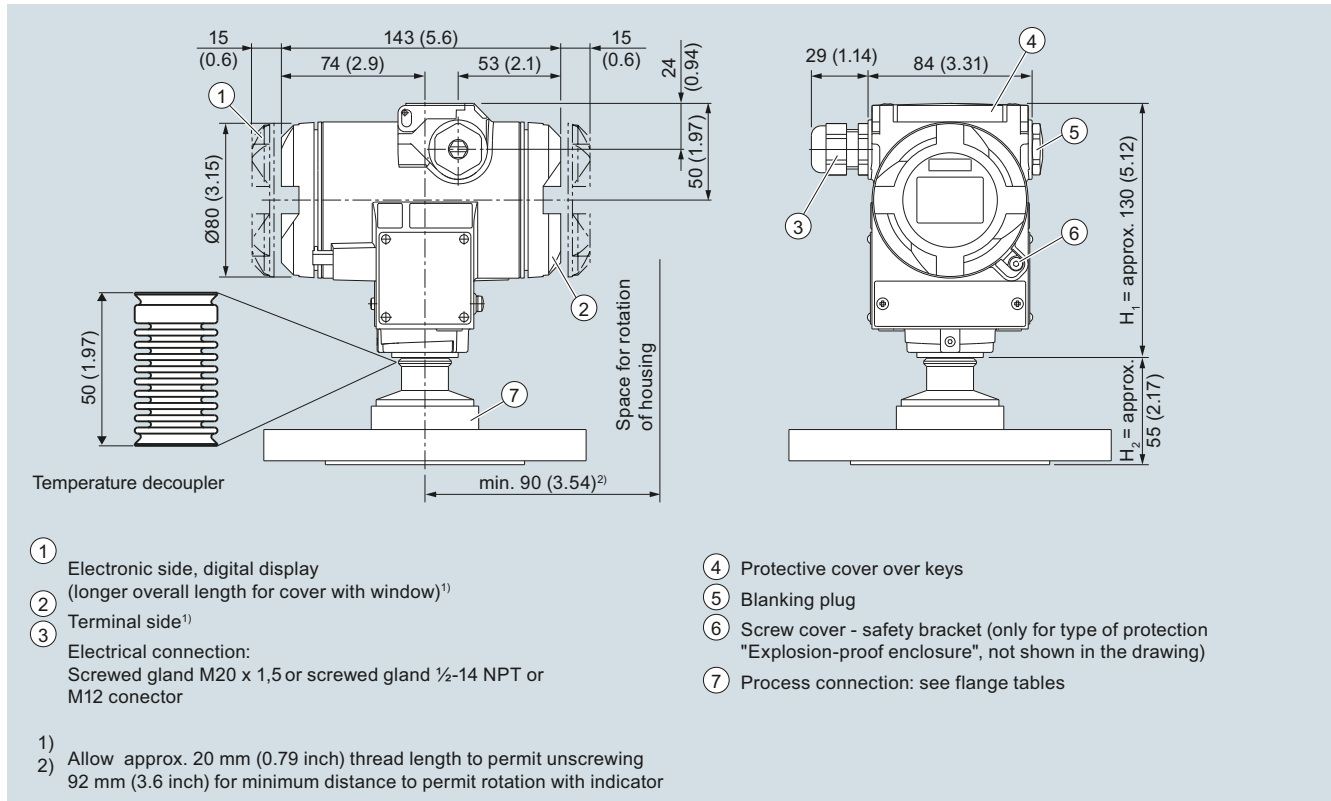

SITRANS P pressure transmitters, DS III series for gauge pressure, with front-flush diaphragm, dimensions in mm (inch)

The diagram shows a SITRANS P DS III with an example of a flange. In this drawing the height is subdivided into H<sub>1</sub> and H<sub>2</sub>.

H<sub>1</sub> = Height of the SITRANS P300 up to a defined cross-section

H<sub>2</sub> = Height of the flange up to this defined cross-section

Only the height H<sub>2</sub> is indicated in the dimensions of the flanges.

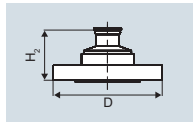
**Flanges as per EN and ASME****Flange to EN****EN 1092-1**

Order code	DN	PN	ØD	H <sub>2</sub>
M11	25	40	115 mm (4.5")	Approx. 52 mm (2")
M13	40	40	150 mm (5.9")	
M23	40	100	170 mm (6.7")	
M04	50	16	165 mm (6.5")	
M14	50	40	165 mm (6.5")	
M06	80	16	200 mm (7.9")	
M16	80	40	200 mm (7.9")	

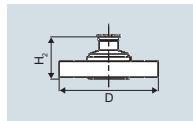
**Flanges to ASME****ASME B16.5**

Order code	DN	PN	ØD	H <sub>2</sub>
M40	1"	150	110 mm (4.3")	Approx. 52 mm (2")
M41	1½"	150	130 mm (5.1")	
M42	2"	150	150 mm (5.9")	
M43	3"	150	190 mm (7.5")	
M44	4"	150	230 mm (9.1")	
M46	1½"	300	155 mm (6.1")	
M47	2"	300	165 mm (6.5")	
M48	3"	300	210 mm (8.1")	
M49	4"	300	255 mm (10.0")	

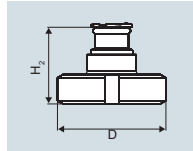
**NuG and pharmaceutical connections****Connections to DIN****DIN 11851 (milk pipe union with slotted union nut)**

Order code	DN	PN	ØD	H <sub>2</sub>
N04	50	25	92 mm (3.6")	Approx. 52 mm (2")
N06	80	25	127 mm (5.0")	

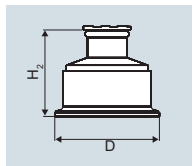
**Tri-Clamp nach DIN 32676**

Order code	DN	PN	ØD	H <sub>2</sub>
N14	50	16	64 mm (2.5")	Approx. 52 mm (2")
N15	65	10	91 mm (3.6")	

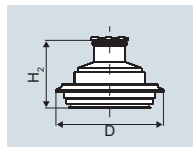
**Other connections****Varivent connection**

Order code	DN	PN	ØD	H <sub>2</sub>
N28	40 ... 125	40	84 mm (3.3")	Approx. 52 mm (2")

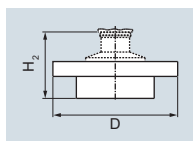
**Sanitary process connection to DRD**

Order code	DN	PN	ØD	H <sub>2</sub>
M32	50	40	105 mm (4.1")	Approx. 52 mm (2")

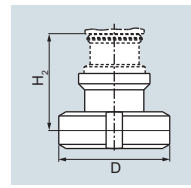
**Sanitary process screw connection to NEUMO Bio-Connect**

Order code	DN	PN	ØD	H <sub>2</sub>
Q05	50	16	82 mm (3.2")	Approx. 52 mm (2")
Q06	65	16	105 mm (4.1")	
Q07	80	16	115 mm (4.5")	
Q08	100	16	145 mm (5.7")	
Q13	2"	16	82 mm (3.2")	
Q14	2½"	16	105 mm (4.1")	
Q15	3"	16	105 mm (4.1")	
Q16	4"	16	145 mm (5.7")	

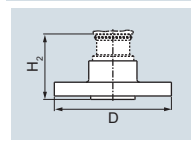
**Sanitary process connection to NEUMO Bio-Connect flange connection**

Order code	DN	PN	ØD	H <sub>2</sub>
Q23	50	16	110 mm (4.3")	Approx. 52 mm (2")
Q24	65	16	140 mm (5.5")	
Q25	80	16	150 mm (5.9")	
Q26	100	16	175 mm (6.9")	
Q31	2"	16	100 mm (3.9")	
Q32	2½"	16	110 mm (4.3")	
Q33	3"	16	140 mm (5.5")	
Q34	4"	16	175 mm (6.9")	

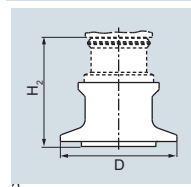
**Sanitary process connection to NEUMO Bio-Connect clamp connection**

Order code	DN	PN	ØD	H <sub>2</sub>
Q39	50	16	77.4 mm (3.0")	Approx. 52 mm (2")
Q40	65	10	90.9 mm (3.6")	
Q41	80	10	106 mm (4.2")	
Q42	100	10	119 mm (4.7")	
Q48	2½"	16	90.9 mm (3.6")	
Q49	3"	10	106 mm (4.2")	
Q50	4"	10	119 mm (4.7")	

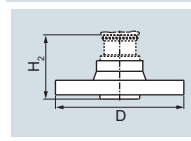
**Sanitary process connection to NEUMO Bio-Connect S flange connection**

Order code	DN	PN	ØD	H <sub>2</sub>
Q72	2"	16	125 mm (4.9")	Approx. 52 mm (2")

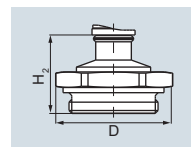
**Threaded connection G¾", G1" and G2" acc. to DIN 3852**

Order code	DN	PN	ØD	H <sub>2</sub>
R01	¾"	60	37 mm (1.5")	Approx. 45 mm (1.8")
R02	1"	60	48 mm (1.9")	
R04	2"	60	78 mm (3.1")	Approx. 52 mm (2")

## Pressure Measurement

Transmitters for applications with advanced requirements (Advanced)

### SITRANS P DS III for gauge/absolute pressure, with front-flush diaphragm

1

#### Tank connection TG 52/50 and TG52/150

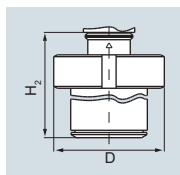

Order code	DN	PN	ØD	H <sub>2</sub>
<b>R10</b>	25	40	63 mm (2.5")	Approx. 63 mm (2.5")
<b>R11</b>	25	40	63 mm (2.5")	Approx. 170 mm (6.7")

#### SMS socket with union nut

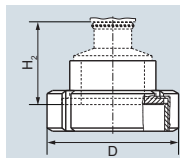

Order code	DN	PN	ØD	H <sub>2</sub>
<b>M67</b>	2"	25	84 mm (3.3")	Approx. 52 mm (2")
<b>M68</b>	2½"	25	100 mm (3.9")	
<b>M69</b>	3"	25	114 mm (4.5")	

#### SMS threaded socket

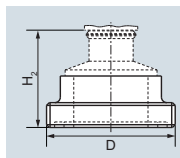

Order code	DN	PN	ØD	H <sub>2</sub>
<b>M73</b>	2"	25	70 x 1/6 mm	Approx. 52 mm (2")
<b>M74</b>	2½"	25	85 x 1/6 mm	
<b>M75</b>	3"	25	98 x 1/6 mm	

#### IDF socket with union nut

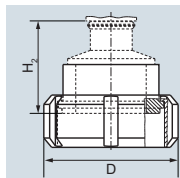

Order code	DN	PN	ØD	H <sub>2</sub>
<b>M82</b>	2"	25	77 mm (3")	Approx. 52 mm (2")
<b>M83</b>	2½"	25	91 mm (3.6")	
<b>M84</b>	3"	25	106 mm (4.2")	

#### IDF threaded socket

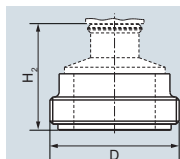

Order code	DN	PN	ØD	H <sub>2</sub>
<b>M92</b>	2"	25	64 mm (2.5")	Approx. 52 mm (2")
<b>M93</b>	2½"	25	77.5 mm (3.1")	
<b>M94</b>	3"	25	91 mm (3.6")	

#### Aseptic threaded socket to DIN 11864-1 Form A

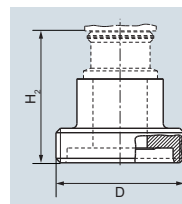

Order code	DN	PN	ØD	H <sub>2</sub>
<b>N33</b>	50	25	78 x 1/6"	Approx. 52 mm (2")
<b>N34</b>	65	25	95 x 1/6"	
<b>N35</b>	80	25	110 x ¼"	
<b>N36</b>	100	25	130 x ¼"	

#### Aseptic flange with notch to DIN 11864-2 Form A

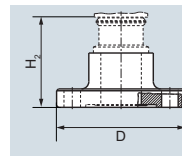

Order code	DN	PN	ØD	H <sub>2</sub>
<b>N43</b>	50	16	94	Approx. 52 mm (2")
<b>N44</b>	65	16	113	
<b>N45</b>	80	16	133	
<b>N46</b>	100	16	159	

#### Aseptic flange with groove to DIN 11864-2 Form A

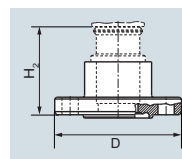

Order code	DN	PN	ØD	H <sub>2</sub>
<b>N43 + P11</b>	50	16	94	Approx. 52 mm (2")
<b>N44 + P11</b>	65	16	113	
<b>N45 + P11</b>	80	16	133	
<b>N46 + P11</b>	100	16	159	

#### Aseptic clamp with groove to DIN 11864-3 Form A

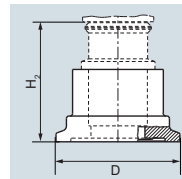

Order code	DN	PN	ØD	H <sub>2</sub>
<b>N53</b>	50	25	77.5	Approx. 52 mm (2")
<b>N54</b>	65	25	91	
<b>N55</b>	80	16	106	
<b>N56</b>	100	16	130	