

Instructions

E87010-A0047-T003-A3-49SA

August, 2012
Supersedes Issue of
December, 1999

Push Button and Selector Switch
See table for class and size use
Class 14, 22, 30,
40, & 43

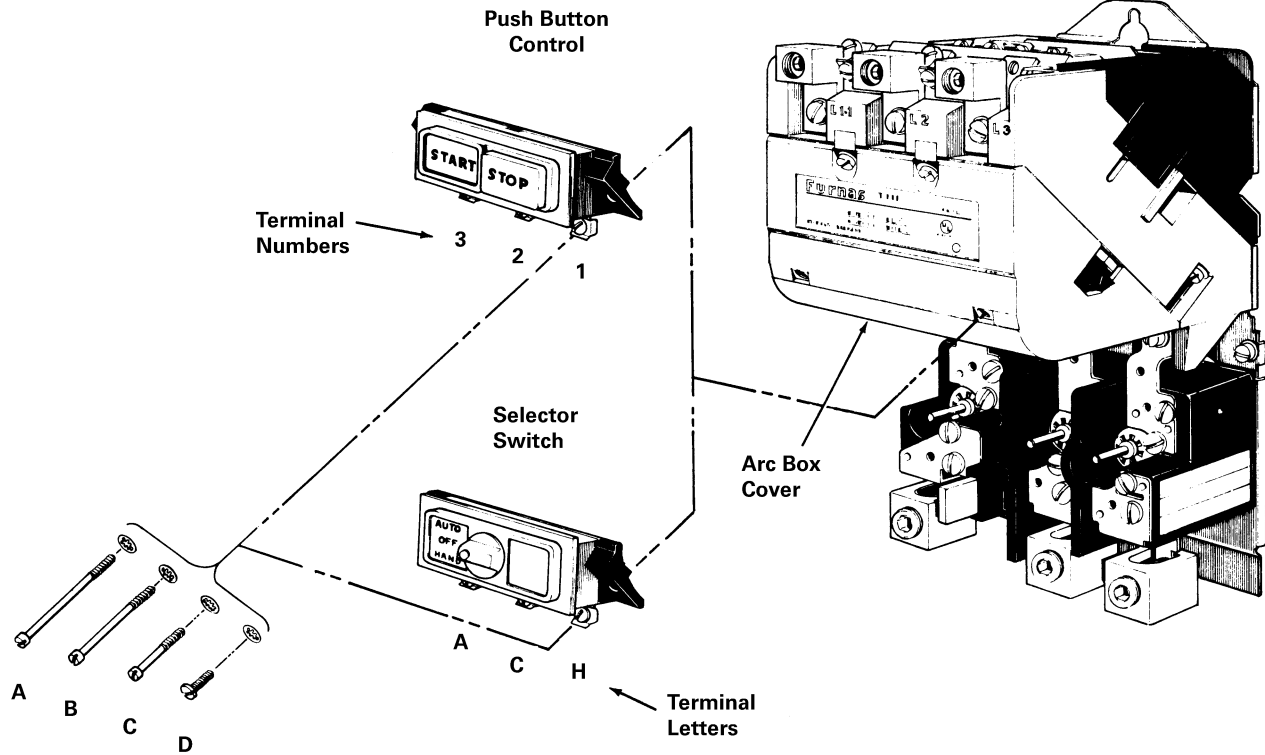

Figure 1

DESCRIPTION

The START-STOP push button provides a momentary 3-wire type of control for use with Furnas Innova starters and contactors. The various selector switches provide a maintained 2-wire type of control when desired. In the AUTO position of the HAND-OFF-AUTO selector switch, a remote pilot device, such as a pressure switch or a thermostat, can be wired to give automatic control for the starter or contactor.

All of the control kits listed in the table can be used on open starters or contactors. Many Furnas NEMA 1 enclosures are designed with cover knock-outs properly located so that the control kits can be used with the starters or contactors mounted within the enclosure.

Rating: NEMA B600 contacts.

Contents of kits:

- 1 applicable push button or selector switch with wire in suitable quantity, length and size for the installation.
- 4 sets of size 6-32 screws with lock washers or self-tapping screws, as follows:
 - 2 A screws to replace arc box cover screws for Model P units, sizes 2 and 2¹/₂

- 2 B screws to replace arc box cover screws for Model P units, sizes 00 through 1³/₄
- 2 C screws for mounting on Model P arc box covers with threaded inserts, sizes 3 and 3¹/₂
- 2 D self-tapping screws for mounting on Model F arc box covers with predrilled holes, sizes 00 through 3¹/₂

Use according to the table:

Kit Description	Catalog Number	For Use with	
		Class and Size	NEMA Type Enclosure
START-STOP Push Button	49SAPB5	14, 40 00 through 3 ¹ / ₂	1, Open
HAND-OFF-AUTO Selector Switch	49SASB1	14, 40 00 through 3 ¹ / ₂	1, Open
OFF-ON Selector Switch	49SASB4	14, 40 00 through 3 ¹ / ₂	1, Open
FOR-OFF-REV Selector Switch	49SASB2	22, 43 00 through 1 ³ / ₄ 2 through 3 ¹ / ₂	1, Open Open
HIGH-OFF-LOW Selector Switch	49SASB3	30 0 through 3 ¹ / ₂	Open

(For Engineering Reference Only - Rev. F)

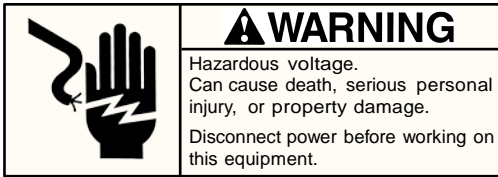

INSTALLATION

1. Secure the push button or selector switch to the arc box cover as shown in figure 1.
 - a. For arc box covers with predrilled accessory mounting holes or threaded inserts, secure the device to the cover with applicable screws C or D.
 - b. For arc box covers where the accessory mounting holes align with the cover screw holes, remove and discard
- existing arc box cover screws. Secure the cover and the device to the starter or contactor with the applicable screws A or B.
2. For use with a Furnas NEMA 1 starter or contactor, remove the knock-out in the cover of the enclosure.
3. For the push button 3-wire control, make electrical connections as shown in figure 1.
4. For the 3-position selector switch, make electrical connections as shown in figures 2, 3, or 5.
5. For the 2-position selector switch, reference figure 4 for typical connections.

Two Position Push Button Station

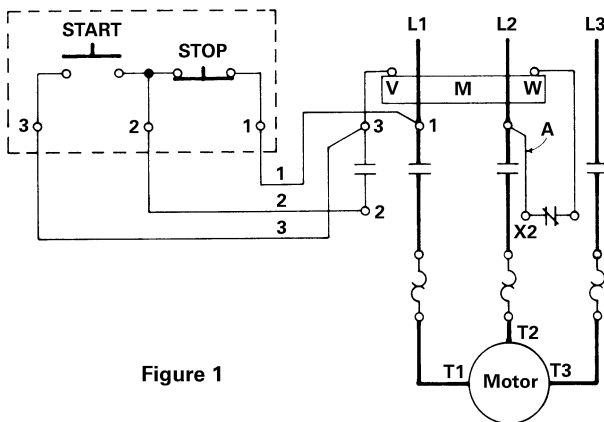

Figure 1

Three Position Selector Switch

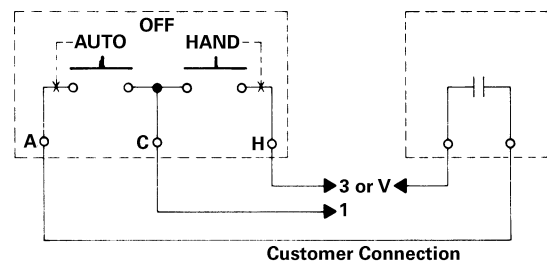

Figure 2

Three Position Selector Switch

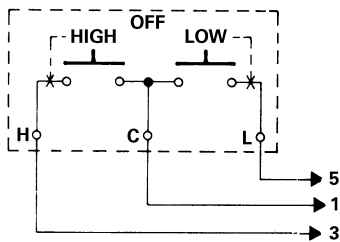

Figure 3

Two Position Selector Switch

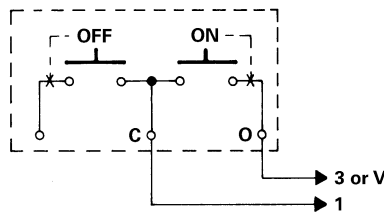

Figure 4

Three Position Selector Switch

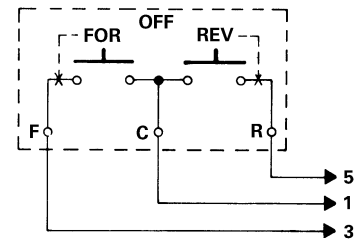

Figure 5